

# CROWN CANOPIES

## Pagoda<sup>2</sup> 6x6m Instruction Manual



**Before assembling or putting up your marquee, read this manual and follow all instructions. Failure to do so can result in damage to the marquee, serious injury and/or death**



### NOTICE

The warnings, cautions, and instructions discussed in this instruction manual cannot cover all possible conditions and situations that may occur. It must be understood by the user that common sense and caution are factors which cannot be built into this product, but must be considered by the installer and/or user.

Tent, canopy, structure, and shelter products are manufactured for use as temporary structures and do not meet structural code unless specified. Since weather is unpredictable, the installer/end user must incorporate their own good judgment, common sense and knowledge of local conditions with the installation instruction guidelines. The installer is responsible for anticipating weather severity for proper time and method of installation

### WARNING SYMBOLS AND DEFINITIONS

	<p>This is the safety alert symbol. It is used to alert you to potential personal injury hazards. Obey all safety messages that follow this symbol to avoid possible injury or death.</p>
<p><b>▲WARNING</b></p>	<p>Indicates a hazardous situation which, if not voided, could result in death or serious injury.</p>
<p><b>▲CAUTION</b></p>	<p>Indicates a hazardous situation which, if not voided, could result in minor or moderate injury.</p>



# PRODUCT SPECIFICATIONS

## Description



### Pagoda<sup>2</sup>

The Pagoda<sup>2</sup> tents are designed with a high peak tube supported by cross cables extending from each corner tube, maximizing the usable space underneath while at the same time eliminating the need for interior frames or support poles. The simple design allows for easy trans-portion, storage, and installation involving only two people due to the reduced amount of hardware in comparison to other frame or pole tents.

## Suggested Equipment

Steps, ground cloth, sledge hammer (or petrol stake driver), UHD 3 way stake puller, Atlas Marquee Lifter.

## Optional accessories

XG Ground Bar System, gutter to Pagoda, gutter to Hex, additional Panoramic Window walls



## Specifications

### 6x6m

Width	20 ft/6.1
Length	20 ft/6.1
Area	400 ft /37.2 m <sup>2</sup>
Eave Height	8'/2.42 m
Overall Height	17.38"/5.3 m
Pitch	8' 9"/2.7 m
Complete Weight	155 kg
Model	Pagoda
Class	Cross Cable
Center Pole	No
Style / Shape	High Peak
Expandable	Yes (with gutter)
Custom Printing available	Yes
Fabric Material	PVC Coated Polyester
Fabric Material Weight	550gsm
Fabric Translucency	Blockout
Water Repellency	Waterproof
Flame Resistant	Yes
UV Resistant	Yes
Mold and Mildew Resistant	Yes
Frame / Pole Material	Aluminum
Longest Component	9'3"/2.82 m
Persons required for setup	2-3
Occupancy	40 Sit Down Dinner-67 Cathedral Seatin



## SAFETY



**STAY ALERT:** Watch what you are doing, and use common sense when assembling / putting up a tent, canopy, structure, or shelter. Do not assemble or put up while under the influence of drugs, alcohol, or medication. A moment of inattention may result in serious personal injury.



**DO NOT OVER LIFT:** The equipment may be heavy and may require 2 or more people to lift and move.



**DO NOT OVERREACH:** Keep proper footing and balance at all times. Use a ladder when necessary.



**DRESS PROPERLY:** Do not wear loose clothing or jewelry. Contain long hair. Keep hair, clothing, and hands/gloves away from power equipment and snag or pinch points.



**USE SAFETY EQUIPMENT:** Eye protection, safety shoes, hard hats, or hearing protection must be used for appropriate conditions

## WEATHER

Since weather is unpredictable, the installer/end user must incorporate their own judgment, common sense and knowledge of local conditions with the installation instruction guidelines. The installer is responsible for anticipating weather severity for proper time and method of installation

- **Rain:** **⚠️WARNING** Rain water can collect on the tent fabric and cause 'ponding' or 'water pocketing' under certain weather conditions, especially if the tent is not installed and tensioned correctly. The additional weight from the water will cause the tent to sag and ponding will continue to get worse. The weight can destroy the tent fabric and/or cause the poles to bend. Highly saturated soil will cause the stakes to lose their holding power.
- **Wind:** **⚠️WARNING** Wind or wind and rain can cause the tension of the tent to change by loosening ratchet assemblies, pulling stakes, and or causing the poles to shift or sink. It is very important to do routine maintenance checks and maintain proper tension on the tent top at all times especially if weather conditions are such that ratchets are beginning to loosen. To achieve wind loading ratings a stake pull test will need to be performed by a qualified engineer.
- **Snow:** Tents, canopies, structures, and shelters are not designed to carry any type of snow loading. These products should not be used if snow of any kind is present, and must be evacuated immediately.

## SITE ANALYSIS

Site analysis is extremely important. The installer must adhere to local building codes and fire regulations. The installer must evaluate each installation site and determine the proper securing and anchoring method and device appropriate for the conditions. Some soils require additional staking or securing methods than what may be/have been purchased with the standard tent package. Crown Canopies instructions summarize all the functions of each product, the rules for using them and suggestions for their use. However, field situations, site conditions, weather and local experience may mandate other methods. Review the following conditions at the proposed site and plan accordingly.

The best site qualities are:

- **Location** Elevated, level, and clear of debris
- **Soil Conditions** Adequate for stable anchoring
- **Space:** Adequate space for the perimeter and external securing ratchets
- **Surface Type:** Grass, Gravel, Concrete, Tarmac, Wood
- **Site Access:** Materials and services can easily be delivered to the site

**⚠️WARNING** Also allow for:

- **Overhead Obstructions** Electrical/telephone lines, tree branches
- **Underground Utilities:** Electric, Gas, Oil, Steam, Telephone, Water, Sewer
- **Weather Effects:** Monitor for extreme weather conditions and evacuate if necessary
- **Emergency Exit Capabilities** Provide evacuation routes in case of a fire or bad weather

## Before You Stake

Ensure that you are fully aware of the type of ground you are staking to, whether it is hard clay or sandy soil, the tent should be secured appropriately. Regardless of the marquee size or weight, no marquee should be put up if it's not possible to use the appropriate amount of stakes or ground anchors that are provided.

**⚠WARNING** Prior to staking, be sure that no underground utilities are present. Crown Canopies is not responsible for methods that installers may choose to erect and secure the tent, canopy, structure, or shelter to the site surface. Crown Canopies responsibility is limited to the manufacture of the tent parts and materials. It is the installer's responsibility, not Crown Canopies, to determine the appropriate number of stakes to meet the necessary wind loads on the installation site.

**⚠WARNING** Soil and setup conditions can vary greatly between installation sites. It is the installer's responsibility to be sure the staking is adequate for each site on each setup. Additional staking, tiebacks, and/or stake bars may be required in order to safely setup and secure the product. Crown Canopies always recommends to use all stakes and securing included with the tent as a minimum.

**⚠WARNING** The number of stakes suggested in this manual routinely does not meet the relevant local codes of the installation site. The number of stakes included in the standard kit will, in most cases, keep the tent, canopy, structure, or shelter setup. Due to various soil conditions the standard staking kit may be inadequate to keep the tent secure in high winds and wet or threatening weather. Regardless of the number of stakes included in standard kits, Crown Canopies makes no representation or warranty as to whether this is sufficient to meet the requirements for your installation site(s).

## Staking Basics

A properly driven stake will be driven down to so lower head is touching the ground. The deeper that the stake is driven, the greater holding strength the stake will have. Anchoring stakes must be driven deep and vertical.





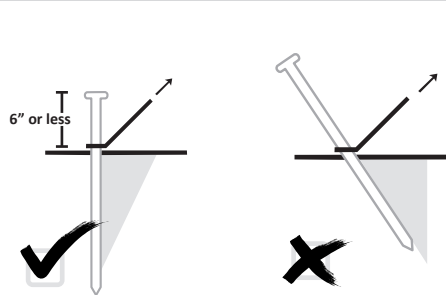
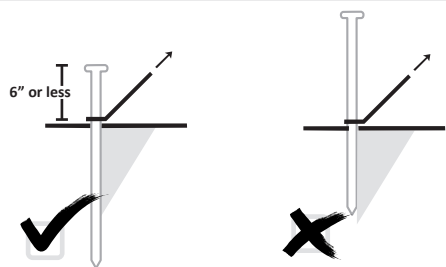





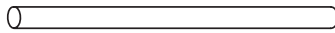
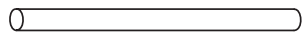
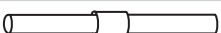

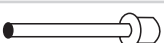
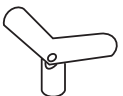
*Find knocking in the stakes tedious? Don't knock in less stakes and compromise safety, see our Stake Driver on [crowncanopies.co.uk](http://crowncanopies.co.uk)*

Stakes driven vertically have a greater holding strength than stakes driven at an angle. Vertically is defined as straight up down or angled up to 10° away from the tent, canopy, structure, or shelter.



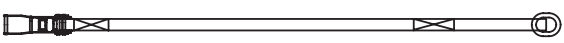

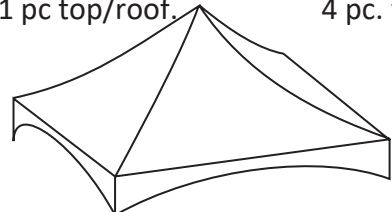
# REQUIRED HARDWARE

## Pagoda

Description (Key)	Size/Color	Qty.	Picture
Eave pole	2.03m / 2.82m	12	
Legs	2.82m	6	
Steel joiners	1.2m	6	
Centre pole		1	
Pole pin		1	
Corner knuckle		6	
Cross cables		3	
Triangle foot		6	 - Standard  - XG
Double head stake	750mm	12	
 <b>A+B.</b> External ratchets	50mm White Ratchet Strap	4	
 <b>C.</b> Rope ratchet	4m Long Strap	4	
NOTE: When the Ratchet Buckle with Loop Strap (A/C) is connected to Loop Strap (B/D) it forms the Ratchet Assembly.			
Tent top and walls			1 pc top/roof.  4 pc. walls (vary per model) 
Tent bag (top and walls come in separate bags)		2	

INSTALLATION

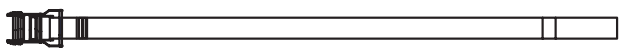
## OPTIONAL ACCESSORIES

Description (Key)	Size/Color	Qty.	Picture
 <b>A+B.</b> Additional external ratchet per leg	50mm White Ratchet Strap	4	
 Add 2x. stakes per foot	750mm	8	
Gutter to 6m Pagoda (12m Hex)			
Gutter to another Pagoda			
UHD 3 Way Stake Puller		1	
Atlas Marquee Lifter (TBD 2020)		1	

# RATCHET PLACEMENT

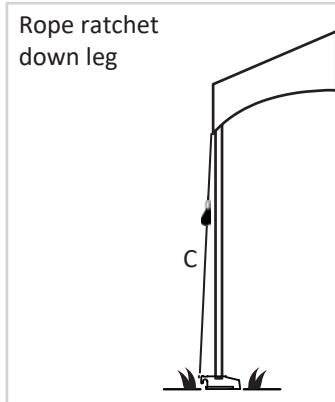
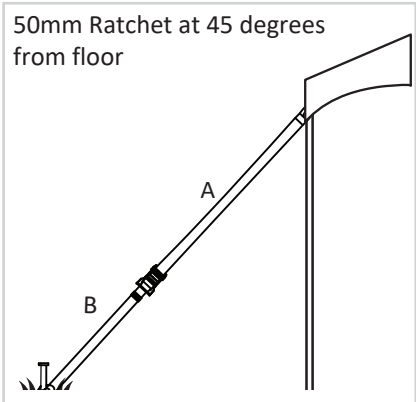

**A.** 50mm ratchet  
**B.** Rope ratchet  
 -> 50mm ratchets should be facing away from the centre and 1.5m away from the foot



# PARTS / MINIMUM STAKING LAYOUT

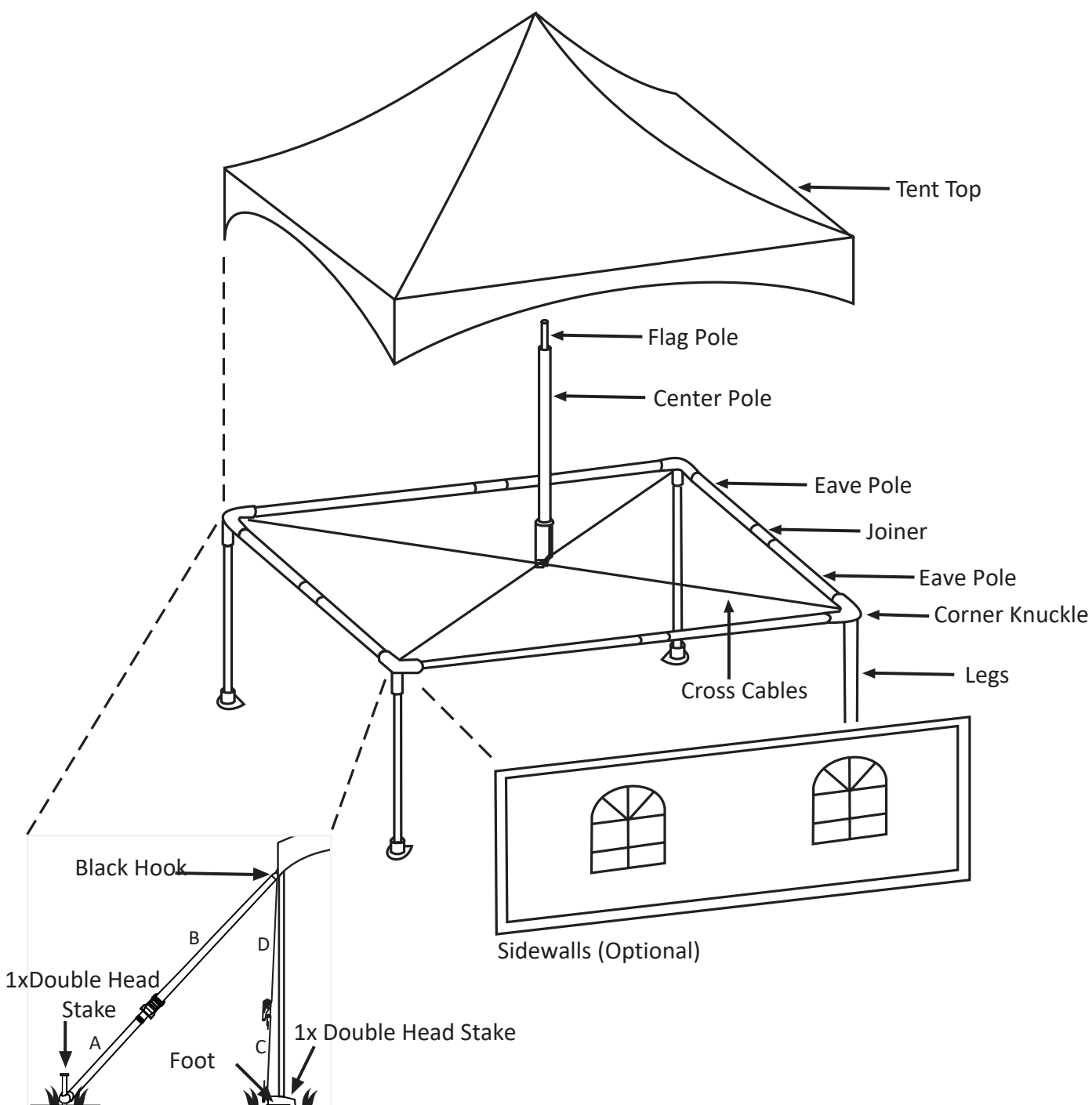

INSTALLATION

## Set Up Instruction

1. Lay out a floor cover in the area the tent will be installed to protect the tent top of dirt and abrasions.
2. Lay out the frame parts on the ground in the approximate location that they will be when the frame is assembled. (See parts/minimum staking layout diagram)
3. Assemble the 4 complete eave poles using two 2.82m tubes joined together with the joiner.
4. Starting at one corner, insert the assembled eave poles into the corner knuckles.
5. Continue to insert all 4 complete eaves into the corner knuckles until a square is formed.

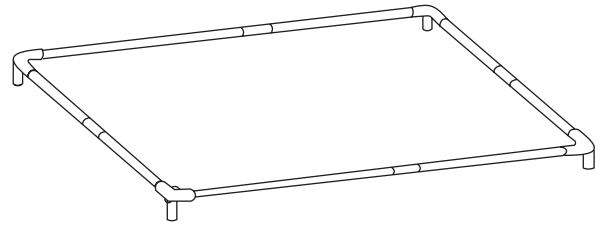
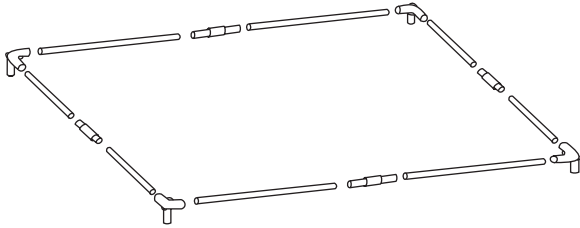

6. Connect one cross cable to the inside hook on the corner knuckle. Connect the other end of this cable to the hook on the corner knuckle at the diagonal corner. Repeat this method to secure other cross cables.
  - a. In order to fit the cable onto the 4th corner fitting hook, you may need to lift the frame up on that corner approximately 4 feet off the ground. This reduces the distance between the corners allowing the cable to reach the 4th corner fitting hook.

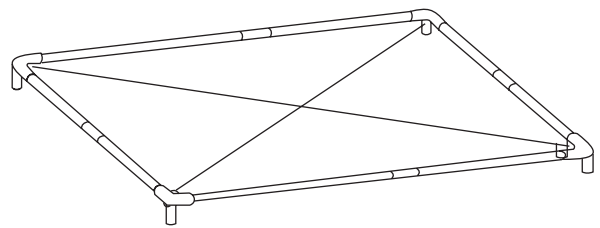
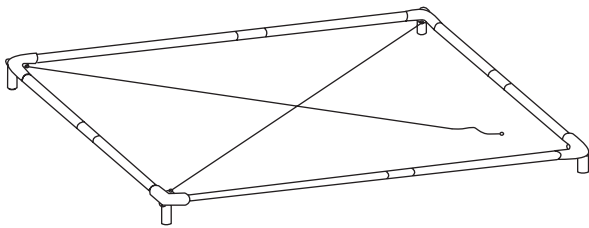

7. Lay the tent top out over the cables and frame with the top of the tent facing upward. Start in one corner by securing the white nylon strap over the ring on the outside of the corner knuckle.
  - a. Continue to secure all the tent corner straps to the outside corner knuckle. Make sure the strap with the O ring is the last strap to be secured. This ring and strap will allow for better grip when securing the top over the last knuckle.

**IMPORTANT: The roof should be gently lifted over the wires to avoid excessive rubbing. Crown Canopies is not liable for holes made when dragging the top without due care.**

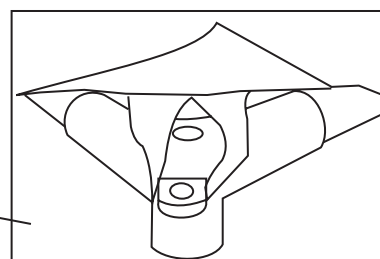
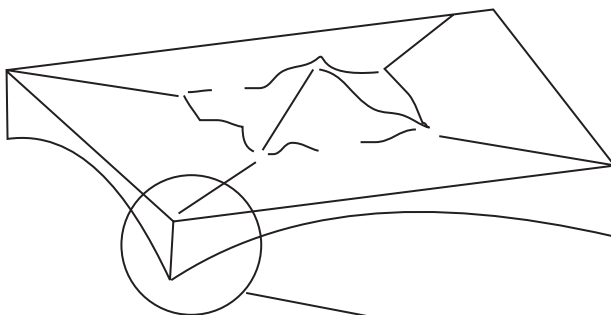

Corner Knuckle

# INSTALLATION INSTRUCTIONS

8. There are 3 straps for each side that connect the eave pole to the PVC top. There are a total of 18 straps. Buckle them around the eave pole and tighten them so they are taut, but not too tight.

**IMPORTANT: Having these straps too tight or too loose can result in water pooling on the roof. Make sure the roof has no areas near the straps where it can collect water (this is sometimes best viewed from above).**



9. Go around each corner knuckle and hook half of the 50mm ratchet (part A with the black end hook end) over the outside hole of the corner knuckle, let the rest hang down. Do this for all 4 corners.

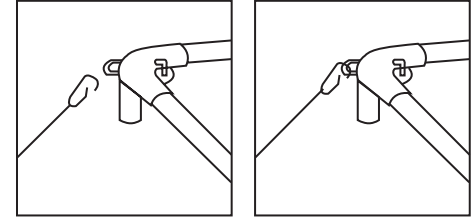

10. 1. *If your stakes have a welded washer for the 2nd head:* Take the short part of the 50mm ratchet strap (part B, with D ring) and put it on the ground where the stake will go (1.5m away from the leg, away from the centre of the tent). Twist the nylon webbing around so it is in the corner of the half circle of the D ring as (shown in photo 1 below).  
 2. *If your stakes have a welded nut for the 2nd washer:* Knock in the stake as the below instructions and tie the ratchet underneath the welded nut using a dog leg knot. You can also do this for step 1 (shown in photo 2 below).

Knock in the stake vertically until the lower head / tied strap is 1cm or less to the ground. The strap needs to be no shorter than 3.4m from the stake to the knuckle, which is just over 1/2 a metre longer than a leg. If it is it will be impossible to lift the tent. There are 2x 50mm straps per corner, assemble in a triangle with 1.5m between the stakes and 1.5m between the stakes and the marquee.

*This step will minimise the chances of the top blowing away during the rest of the installation*



11. Once the top is in place and secured, you're ready to install the legs. Lift one side of the tent up and install two of the legs at each corner, leaving the tent at an angle. Attach the feet and rope ratchet assembly to each leg as you install the legs. You can hook the string end with the metal quick link on the O ring of the foot and then pull it up the leg and hold it all together. *This will ensure the feet stay on as you finish assembly.* Then insert 1 more leg so you have 3 legs in place with the tent still at an angle.

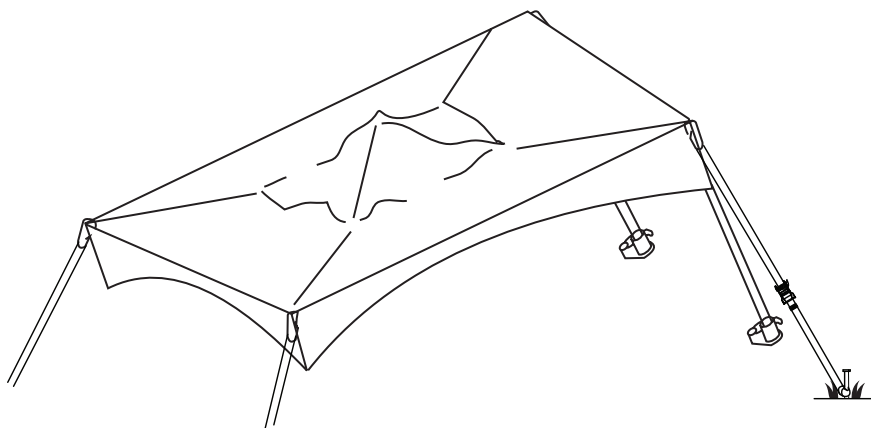

XG:





# INSTALLATION INSTRUCTIONS

12. As each leg is inserted, attach the metal quick link of the rope ratchet (part C) to the string on the tent top.

Screw it closed to ensure it won't come off with movement.

**IMPORTANT: Do not hook the ratchet onto the D rings or onto the rope incorrectly. Doing this can cause water pooling and damage the marquee. See step 17 for more details**



13. The rope ratchet should now connect the top and the foot. Pull on the loose end of the rope to tighten it. Go around and tighten the rope ratchets equally, the black ratchet part should be around half way up the leg. The foot should be pointed towards the inside (center) of the tent, with the eye nut on the outside (the below photo is from the outside pointing in). Tighten the rope ratchet by pulling on the loose end until the rope is taut, but only enough so that the foot cannot fall off the leg.

Standard:

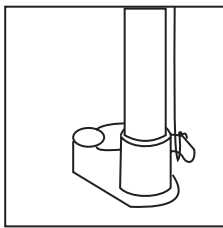

XG:



14. Now you need to install the center mast through the tent top. Place the center mast pin at the top of the center mast pole. Unhook the clip at the bottom of the center mast pole and position the bottom of the center mast pole onto the **top cable**. Making sure the mast pin at the top is through the hole and is visible from the outside of the tent top, slide the center mast pole up the cable toward the intersection of the cables. Move the center mast pole to the center of the tent making sure it rests on both cross cables. Once in place, put the clip back on the bottom of the center mast pole making sure it is under both cables to keep it in place.

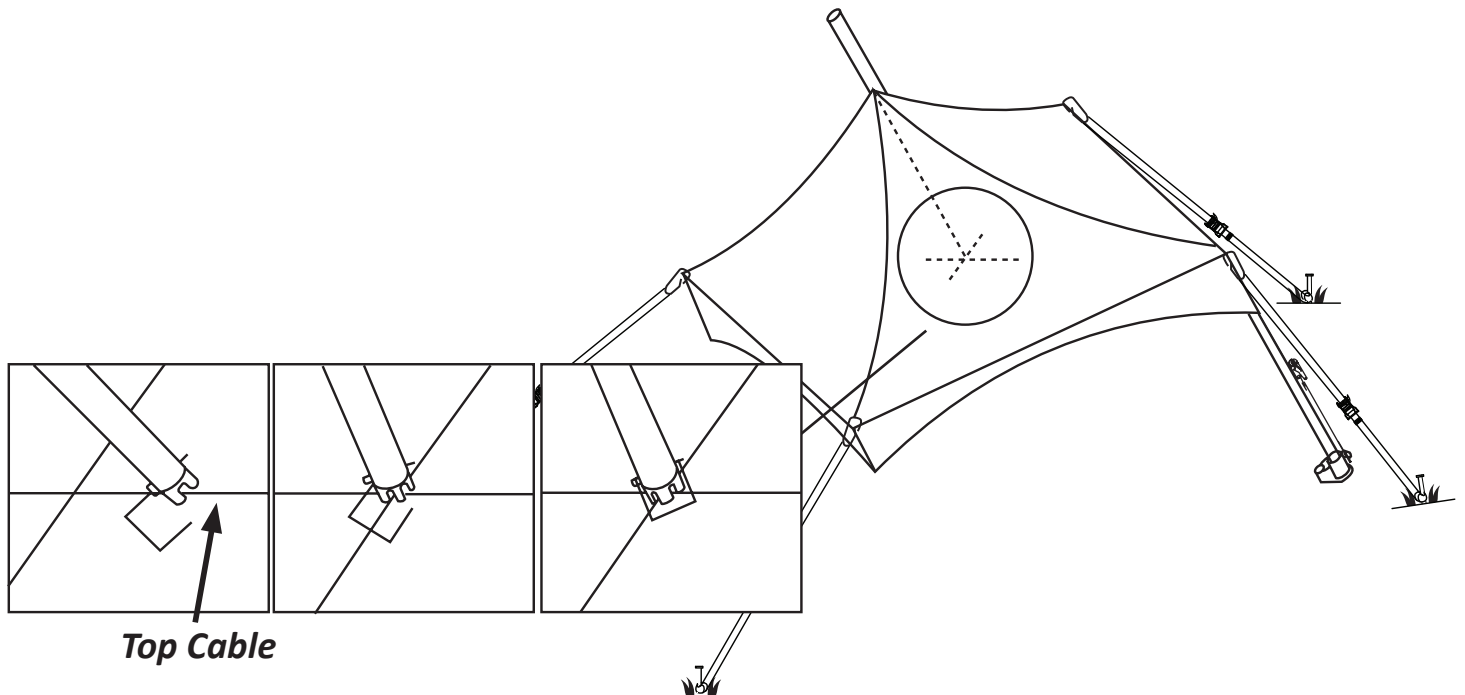

INSTALLATION

15. Install the remaining 2 legs and rope ratchets; be sure the feet are all pointing towards the center as shown in step 14.

**IMPORTANT:** The last 2 legs are the most difficult and will require 2-3 people to lift and insert the legs. Use 2 people on steps to hold each side of the corner knuckle while the other inserts and push up with the leg.

*Failure to use enough people can result in injury. It is recommended to use more people while you are less experienced.*

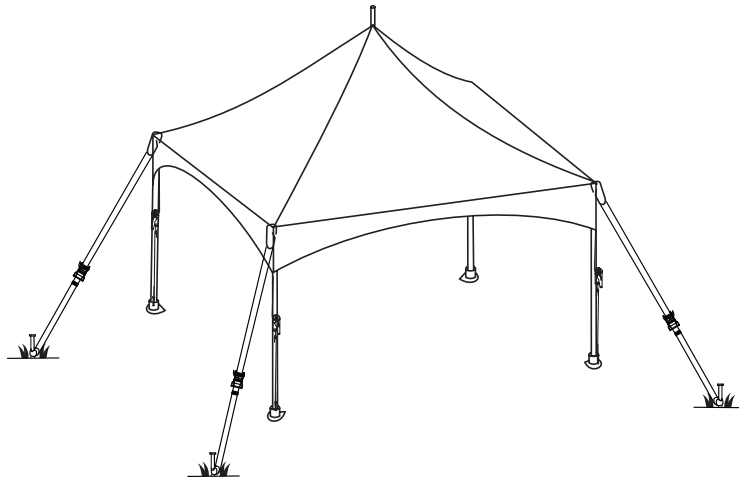

16. Make sure the legs are straight then secure each foot by driving a 1x double head stakes through a hole (if you are using the recommended 50m storm ratchet). If you are not using the storm ratchet use 2x double head stakes per foot. Ensure the stakes are driven down to the lower head and vertically / less than a 10° angle.

Standard:

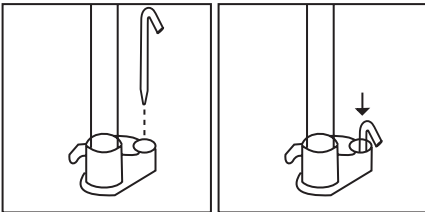

XG:



17. Check all rope ratchets (down the legs) are attached properly and tighten them as much as possible with your own body weight.

**IMPORTANT:** Failing to connect the rope ratchets properly or tighten them enough can result in water pooling on the roof and damage to the marquee.



18. Roll excess ratchet straps and secure into the ratchet buckle.



## Walls Setup Instructions (This step is optional)

The sidewalls are designed to hang around the outside of the legs with the ratchet assembly on the exterior of the sidewalls.

- a. Hang each sidewall by buckling the straps on the top of the side wall around the eave pole that runs around the perimeter of the tent. Each sidewall will cover the distance between two legs. Loosen the tent top tension if it is difficult to get the straps around the eave pole.
- b. Tighten the hanging straps so the sidewall is hanging at the appropriate height or fit with the ground surface the tent is sitting on. Tuck the ends of each sidewall between the ratchet assembly and the tent leg. Make sure the sidewall is centered between the two legs.

*Hang the walls as high as possible if using the XG ground bars*

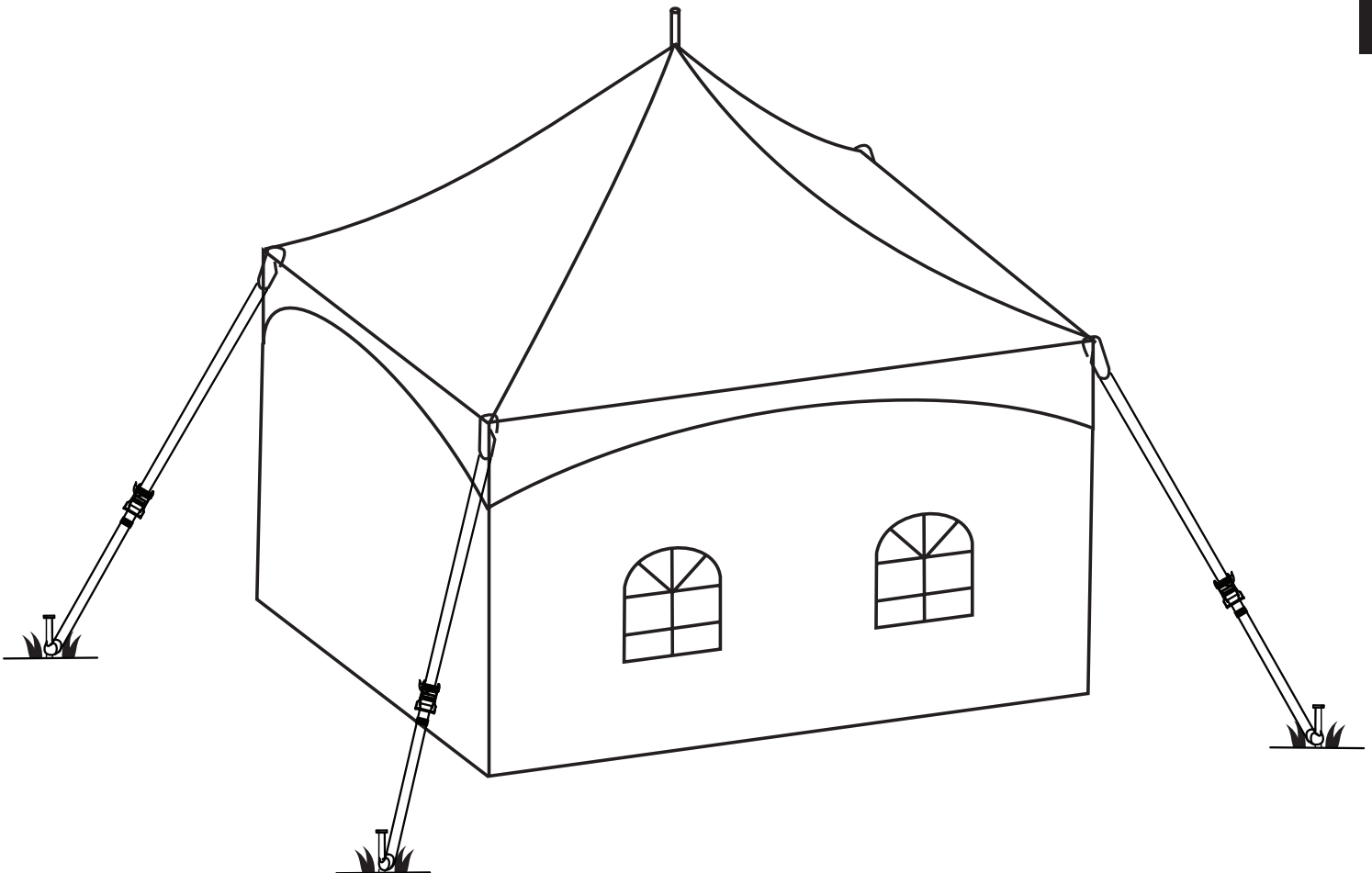
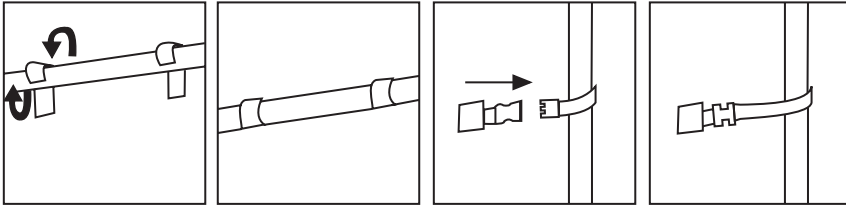

## Taking the tent down

1. Loosen all ratchets.
2. Remove stakes from the feet. If you find this tedious consider the UHD 3 Way stake puller.
3. Remove the rope ratchets down the legs.
4. Remove 2 legs from one side of the tent and carefully set the tent frame on the ground.
5. Remove the center mast assemblies
6. Remove opposite side legs.
7. Unfasten the corner straps, completely disconnecting the tent top from the frame and stakes.
8. Remove the 50mm external ratchets.
9. Roll out a drop cloth next to the frame.
10. Carefully remove the tent top from the frame, lifting up on the fabric or “flapping” it to create a cushion of air.
11. Fold and roll the tent top as tight as possible. Remember not to stand or walk on the tent top fabric.
12. Use the included protective shipping bags or contact us for larger bags
13. Disassemble all cables and fittings. Work from the perimeter of the frame inwards.
14. Fold and roll up the drop cloth.
15. Remove remaining stakes.

IF YOU NEED TO PUT THE MARQUEE AWAY WET, ENSURE IT IS DRIED AT THE EARLIEST POINT POSSIBLE. THE LONGER IT IS LEFT DAMP OR WET THE MORE DAMAGE THAT CAN BE CAUSED BY MOULD AND MILDEW

Crown Canopies PVC has passed UK fireproof tests to BS7837. Open flames should never be used under any tent, canopy, structure, or shelter. The below fireproof certificate can be shown to fire officers at public events.



# TEXTILE LABORATORY SERVICES LIMITED

P.O. Box 50, Wharfedale Business Centre, Ilkley Road, OTLEY, LS21 3JP, United Kingdom

Tel: +44 (0)1943 850967 Fax: +44 (0)1943 850965 Email: info@tls-ltd.demon.co.uk

Regd. Office: 1 Victoria Road, Guiseley, England - No. 1966347



The test report shall not be reproduced except in full, without written approval of the laboratory

## TEST CERTIFICATE

No. 33650/1

**Client** **Crown Canopies**  
 Narracott Barn  
 Putford Holsworthy  
 Devon  
 EX22 7XL.

**Fabric Reference** **550g Opaque PVC**  
 Descriptions are information  
 supplied by the client

**Dimensions (approx)** **115cm by 124cm**

**Sample received** **18/11/2013**

**Testing to BS 7837 : 1996 Flammability performance for textiles used in the construction of  
 marquees and similar structures using BS 5438 : 1989 - Test 2B Limited Flame Spread -  
 Bottom Edge Ignition**

**PRETREATMENT:** Water soak according to BS 5651 : 1991, Clause 3

### TESTING

Three specimens from both length and width were conditioned and tested in accordance with the above standard using butane gas with a 10 second flame application time applied to the raw bottom edge of the fabric. The results obtained are shown below

Specimen	LENGTH				WIDTH	
	1	2	3	4	5	6
Duration of flaming(s)	1	1	0	0	0	0
Duration of afterglow(s)	4	2	0	0	0	0
Flaming Debris separated	No	No	No	No	No	No
Flame reached an edge	No	No	No	No	No	No
Hole reached an edge	No	No	No	No	No	No
Glow reached an edge	No	No	No	No	No	No
Filter paper flames/smoulders	No	No	No	No	No	No
Damaged length (mm)	80	65	60	60	70	75

For at least 5 of the 6 specimens IF: A) Flame duration is not greater than 5s B) The lowest boundary of any flame does not reach the upper edge or any vertical edge C) The filter paper does not smoulder or flame the result is a PASS

If more than 2 specimens show any of the above effects the result is FAIL

If 2 specimens show any of the above effects test a further 6 specimens - if 5 of these specimens show none of the above effects the result is a PASS

### CONCLUSION

The fabric tested meets the requirements of BS 7837 : 1996 Flammability performance of textiles used in the construction of marquees and similar textile structures

J.M. Brown .....  
 C Chem MRSC C Text FTI  
 Managing Director & Authorised Signatory

Checked by.....

## TENT CARE

For maximum life of the PVC, Crown Canopies recommends regular cleaning with the use of a soft brush with neutral soaps or cleaners, such as dish soap, or warm water. Thorough rinsing and drying is required before storing the fabric.

### **Things that will cause premature degradation and may reduce life expectancy of a tent:**

- Improper handling during installation/dismantling on rough surfaces will create pinholes and abrasions. ALWAYS USE A DROP CLOTH/GROUND CLOTH DURING INSTALLATION AND DISMANTLING.
- Walking on the fabric during installation/dismantling will create pinholes and abrasions.
- Extended use of the tent without cleaning
- Accumulation of dirt on the PVC surface will promote the growth of mold and mildew and premature wear.
- Storage of PVC that has not been dried thoroughly. Even a slightly damp product can promote the growth of mildew when folded and stored. Mould and mildew may require harsh cleaners to remove, which may cause premature wear. The best solution is to take every precaution to keep mould and mildew from growing in the first place. NEVER STORE A TENT, CANOPY, MARQUEE IN A WET OR DAMP CONDITION.
- Harsh detergents and cleaners, which contain a solvent or bleach. The longer the exposure of PVC to these products, the more it will reduce the life of the PVC vinyl.
- High-abrasive cleaners, including wire brushes, power washers and/or commercial washing machines will result in premature wear and deterioration of tent fabrics.
- Wind whip – Loosely tensioned fabric that whips in the wind will damage over time.
- Squirt a little bit of WD40 in the rope ratchet every few months to keep it moving smoothly

### **Repair work**

Crown Canopies recommends repair work based on the type and extent of the damage. Where possible the PVC can be repaired with a small repair kit, or rewelded by a local manufacturer. Zips can be replaced and new Velcro can be sewn on. Contact us for free guidance before undertaking repairs.

## PRODUCT WARRANTY

Crown Canopies warrants that this product will be free from defects in material and workmanship for a period of one (1) year for the PVC and five (5) years for the framework following the date of purchase. Defects are limited to any defect which is a result of the manufacturing process. Excluded are holes, punctures, corrosion or other damages which can be caused during normal installation of a tent whenever proper procedures are not followed. Crown Canopies at its option will repair or replace this product or any component of product found to be defective during this warranty period. This warranty is valid for the original purchaser only, and is not transferable. This warranty does not cover normal wear or damage resulting from negligent use or misuse of the product, use contrary to instructions, repairs or alterations by anyone other than Crown Canopies, or forces of nature. Crown Canopies is not responsible for methods that installers may choose to erect and secure the tent to the ground. Crown Canopies responsibility is limited to the manufacture of the tent parts and materials.

This warranty is in lieu of all other warranties, and there are no warranties, expressed or implied, including warranties of merchantability or fitness for a particular purpose, which extend beyond the description on the face hereof. Crown Canopies shall not be liable for any incidental or consequential damages.